

REVISIONS			
REV.	DESCRIPTION	DATE	REV BY
A	Preliminary	2022-07/27	RM

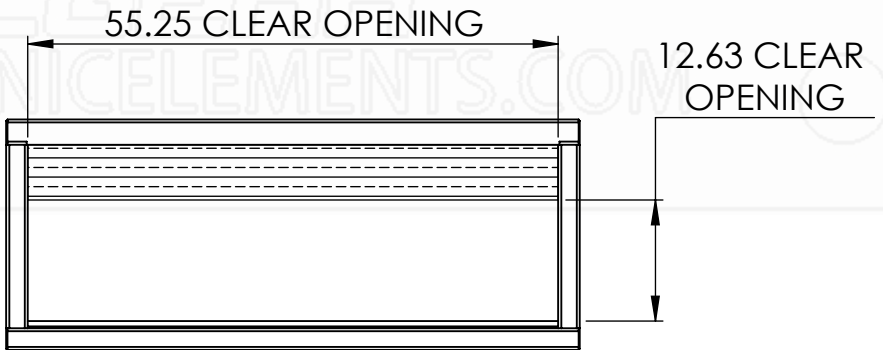
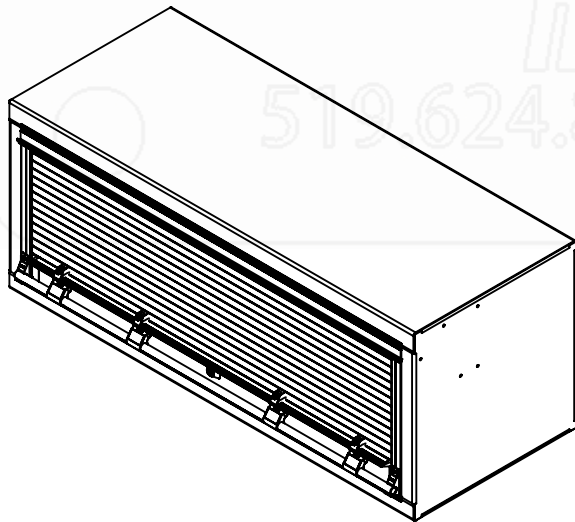
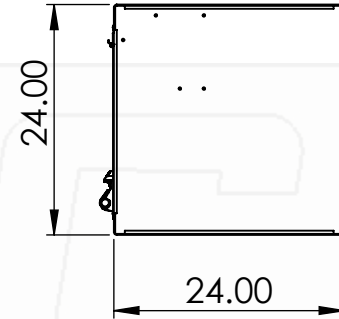
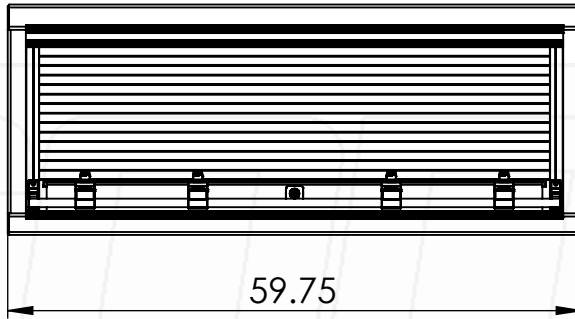

Part No.:

1082

MATERIAL: 5052 (Alum)

THICKNESS: 0.125

FINISH: Smooth

DWG. NO.: 3152-0-00-A

Approx. Weight: 87.14 lbs

Surf. Area: 143.23 sq. ft.

ICONIC ELEMENTS (ICONIC METALGEAR) TITLE:

PROPRIETARY AND CONFIDENTIAL
NO PART OF THIS DOCUMENT MAY BE REPRODUCED, STORED IN A RETRIEVAL SYSTEM, OR TRANSMITTED IN ANY FORM, WITHOUT THE WRITTEN PERMISSION OF Iconic Elements Inc. (ICONIC METALGEAR)

602424 Roll Up Door Box

REV: SHEET:

A 1 OF 1