

SECTION A-A

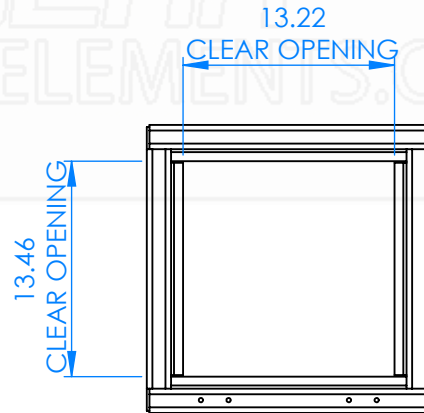

Part No.:

1175

MATERIAL: 3003 (Alum)

Approx. Weight: 36.57 lbs

Surf. Area: 38.14 sq. ft.

THICKNESS: 0.125

ICONIC ELEMENTS (ICONIC METALGEAR) TITLE:

PROPRIETARY AND CONFIDENTIAL
NO PART OF THIS DOCUMENT MAY BE REPRODUCED, STORED IN A RETRIEVAL SYSTEM, OR TRANSMITTED
IN ANY FORM, WITHOUT THE WRITTEN PERMISSION OF Iconic Elements Inc. (ICONIC METALGEAR)

FINISH: Checker

181824 FD w/ Chains

DWG. NO.: 3295-C-00-A

REV: SHEET:

A 1 OF 1